



The generation of continuous membrane surfaces

Marco BAHR¹, Toni KOTNIK²

¹ETH Zurich, Chair of Structural Design
Wolfgang-Pauli-Strasse 15, HIL E45.1, CH-8093 Zurich, Switzerland
marco.bahr@arch.ethz.ch

²ETH Zurich, Chair of Structural Design

Abstract

Recent interest in freeform architecture has dramatically changed the type of surfaces under consideration, from statically optimized shell structures to shapes that have been determined by non-structural design decisions. Based on the theory of plasticity a new method has been developed which allows the design engineer to control the transfer of loads in any kind of surface structure. By this novel approach curved stress fields are generated which can either be used to analyse a given structure or to design shapes.

Keywords: surface structures, design, analysis, stress fields, equilibrium solutions, theory of plasticity

1 Introduction

Due to increasing use of digital design methods over past decades, the type of curved surfaces used in architecture has changed dramatically: from being statically dominated to an increasingly architecturally determined formal language [1, 2]. As a result, the technical investment for realising these free-form structures at times has assumed considerable dimensions. Hence, a method is required which is able to unify the architectural freedom of design with the engineer's pursuit of efficient structures. Building on the principles of graphic statics and the theory of plasticity the proposed method in this paper is a step towards such conciliation of physical necessity and freedom of design.

2 Basic idea and procedure of the proposed method

For arch structures under given load conditions a thrust line can be found. Using a rigid-plastic material model it can be stated that, as long as the thrust line stays within the section of the arch, it is only loaded by internal compressive forces. However, if the thrust line leaves the section additional internal flexural loads will occur. The area in between the arch section and the thrust line coincides with the internal flexural load of the arch. Corresponding to thrust lines for one-dimensional systems, we propose a comparable approach for surface structures. In reference to membrane theory, which describes a plane strain for curved surface structures, the extension of thrust lines to the second dimension is denoted as membrane surface. Approaches, comparable concerning the basic idea of the presented method, only deal with specific problems in connection

with vaults or sails [3, 4], but do not yet give a generally applicable solution for generating the form of surface structures.

The fundamental idea of the proposed method is strongly influenced by stress field analysis [5, 6], which bases on the lower bound theorem of the theory of plasticity and a rigid-plastic material model. The lower bound theorem of the theory of plasticity states that any solution for load transfer is possible as long as the system is in equilibrium and below yield [5, 7]. When using a rigid-plastic material model, elastic deformations are neglected. This assumption is justified if sufficient ductility is assured [6], which applies for most concrete structures, as long as several constructional rules are obeyed [8]. The stress field method allows the design engineer to control load transfer in beams and walls. Although stress field analysis is a powerful tool, it can, however, only be used to describe the transfer of in-plane loads. In order to develop stress fields for surface structures like plates, shells or folded plate structures the transfer of out of plane loads must also be describable.

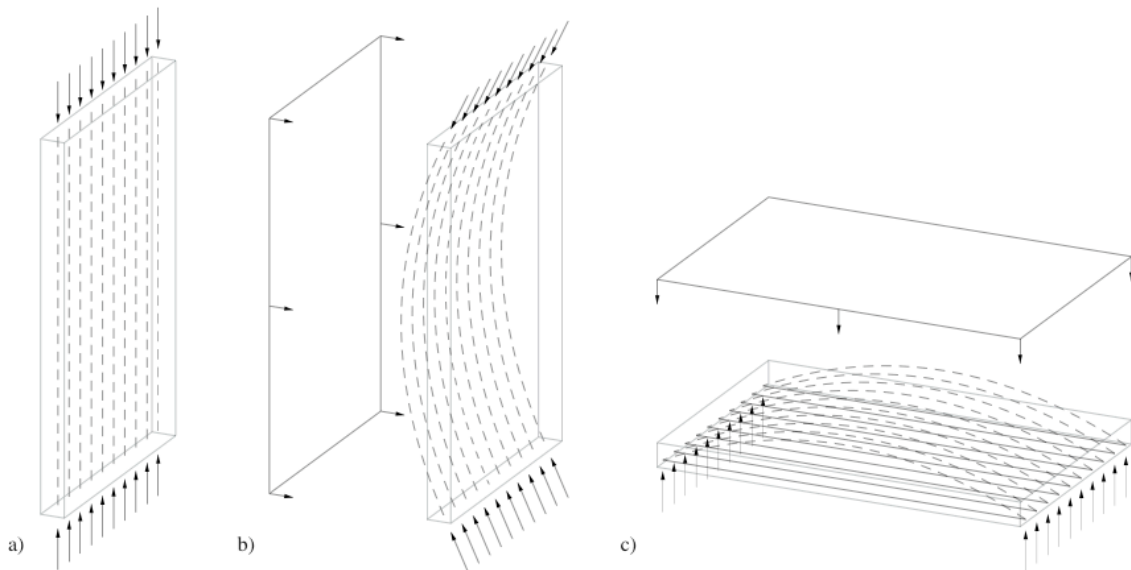

Fig. 1: a) wall element under in-plane load, b) wall element under additional out of plane load, c) plate element under out of plane load

A wall element under in-plane load and a resulting stress field is shown in figure 1a. When superposing the in-plane loads with out of plane loads, the stress field must curve in order to assure equilibrium (fig. 1b). If the stress field leaves the solid as illustrated in figure 1b, internal flexural load will occur in the wall element. A curved stress field can also be used to describe load transfer of out of plane loads of a plate (fig. 1c). Since supports of plates are in general not able to bear horizontal thrust, an additional tensile stress field needs to be introduced to equilibrate the curved compressive stress field. The two stress fields and the space in between describe the internal flexural loading of the plate and coincide with the bending moment diagram of this particular example.



This procedure to determine internal flexural loads by a curved compressive stress field and a tensile stress field is the adaptation of a method used to describe internal flexural loads of linear structural elements by means of arches and cables [9]. This approach for linear structural elements has been a main inspiration to use membrane surfaces not only to describe shells, but also for solely flexurally loaded structures like plates.

The presented method aims at developing curved stress fields for all kinds of load transfer in any solid surface structure under consideration. Due to the immense statical indeterminacy of solid surface structures, for a particular loading a wide range of solutions can be found using the lower bound theorem of the theory of plasticity. In contrast to stress fields describing in-plane load transfer, the form of curved stress fields is not only unknown, but also even dependent to load transfer. In order to maintain the principle of a highly controllable load transfer, an intermediate step is advantageous. A projection surface, which represents a projection of the aspired membrane surface, is introduced. By this means an initial surface is obtained to define load transfer. To use a projection of the aspired system as an intermediate step to develop a form, which is free of flexural loads, has also been proposed by Block [3].

Usually the term projection is used to describe a geometrical operation by which one of the components of a vector is set to zero. From a curved surface a planar projection is obtained. Within the scope of the proposed method, projection is defined wider. In contrast to common comprehension, a projection surface does not have to be planar and the direction of projection may vary at every point. Projection in terms of this method is the movement of a point of the projection surface along an assigned projection vector. Projection will thus base on two elements. The projection surface gives an initial surface on which loads are applied and an initial state of stress is created. And additionally to the projection surface a set of projection vectors is introduced, which defines a specific direction of projection for every point of the projection surface. The projection surface and the assigned projection vectors are chosen according to the specific problem under consideration. Choosing a planar projection surface and using its normal vectors as projection vectors is probably the easiest possible way to find a solution and will also be suitable for a wide range of problems. However, in case of closed surfaces like cylinders or hyperboloids or in case of a given structure, which has to be analysed, more advanced projection surfaces and assigned projection vectors will be necessary.

The load transfer on the aspired membrane surface is mainly controlled by the arrangement of load transfer on the projection surface. A curved stress field can be seen as an infinitely tight grid of interacting arches or cables bearing the applied loads. The projection of this grid on the projection surface will be denoted as initial load paths.

A load bearing arch or cable will always cause horizontal thrust. If the horizontal thrust was zero, these structures would not be able to bear loads. Obviously horizontal thrust is necessary to activate this particular load bearing action. The same applies for shell structures. Since a membrane surface describes the statically ideal form of a shell structure under a particular load condition, forces comparable to horizontal thrust are necessary to activate load transfer along a membrane surface. These forces will be denoted as initial forces. These initial forces are assumed to be acting along the initial load path curves on the projection surface. The magnitude of initial forces is a scaling



factor for the membrane surface and must be different from zero if loads shall be transferred along a particular load path curve on the membrane surface.

The final curved stress field, the shape of which is representing the membrane surface, is obtained by superposition of the initial state of stress on the projection surface and the applied external loads. From superposing initial forces with loads, a change of direction of these forces results. To assure that these forces acting along initial load path curves remain tangential, the curves have to deform. The distribution of loads to the particular load path curves in turn has to be adapted such that a continuous surface results.

Since the membrane surface is describing the form of a curved stress field, it is not necessarily coinciding with a real structure. The curved stress field is just describing an equilibrium solution for the internal loads of a structure under a specific load condition. Thus, it is not necessary that a membrane surface ends at the position of supports, but at least at the projections of the supporting points. The distance between the membrane surface and the real structure shows the existence of an internal flexural load. The same applies for the membrane surface at its supports. If the boundaries of the membrane surface do not lie within the real structure at its supporting points, clamped supports will be necessary in order to achieve the chosen load transfer.

3 Generation of continuous membrane surfaces

In this section a method to generate continuous membrane surfaces is presented. The method has been developed in dependence on geometric flows in differential geometry [10].

3.1 Projection

The projection surface as an initial surface is used to define initial load paths of choice for the surface structure under consideration. The following mathematical definition must therefore apply as a prerequisite.

A projection surface is defined as the map of a compact, simply connected subset A of \mathbb{R}^2 into \mathbb{R}^3 by a differentiable, injective function \mathbf{p} .

Thus the position vector of every point on the projection surface is determined by the vector function \mathbf{p} . Although the symbol \mathbf{p} represents the vector function it will also be used to address the projection surface itself.

The direction of projection is defined by a differentiable vector field, which assigns a projection vector \mathbf{n}_p to every point on the projection surface \mathbf{p} . Differentiability has to be provided to obtain a differentiable membrane surface. As the further description of the method will demonstrate projection has to be distinguished into two fundamentally different cases, constant projection and varying projection. In case of constant projection to every point on the projection surface the same projection vector is assigned. In contrast varying projection means to assign a different projection vector to every point on the projection surface. However the direction of projection is assumed, it



has to be assured, that the projection vector \mathbf{n}_p is not tangential to the projection surface and thus not a linear combination of two tangent vectors to the projection surface.

3.2 Initial load paths

As the proposed method bases on the lower bound theorem of the theory of plasticity there exists an infinite number of solutions for a particular problem. By defining load paths, which can be imagined as a set of projections of arches or cables, load transfer in the surface structure under consideration is consciously chosen. Since load paths define the direction of load transfer, it also determines the directions of initial forces. In order to describe any kind of in-plane state of stress two sets of load path curves need to be chosen. Furthermore two load path curves have to be chosen as borderlines, across which no load is transferred. The intersection point of these, for which applies that the projected state of stress coincides with its preimage, is denoted as starting point. By the position of borderlines the direction of load transfer across them is defined, as loads are only transferred away from there to the supports.

Mathematically the choice of load paths means a reparametrisation of the vector function defining the projection surface, such that its derivatives with respect to the introduced parameters give two tangent vector fields, which describe the directions of load transfer. It is advantageous to reparametrize the vector function \mathbf{p} with the arc lengths s_{pj} and s_{pk} , because its derivatives will directly give the necessary unit tangent vector fields. The choice of borderlines means mathematically to create a two-dimensional coordinate system with the starting point as origin and the borderlines as axes. The direction of increasing arc lengths is defined by the direction of the tangent vectors to the projection surface along the borderlines.

The unit tangent vectors at \mathbf{p} describing the direction of load transfer are determined by:

$$\mathbf{t}_{pj}(s_{pj}, s_{pk}) = \frac{\partial \mathbf{p}(s_{pj}, s_{pk})}{\partial s_{pj}} \quad \mathbf{t}_{pk}(s_{pj}, s_{pk}) = \frac{\partial \mathbf{p}(s_{pj}, s_{pk})}{\partial s_{pk}} \quad (1)$$

or if the arc lengths s_{pj} and s_{pk} are not determinable:

$$\mathbf{t}_{pj}(h_j, h_k) = \frac{\partial \mathbf{p}(h_j, h_k)}{\partial h_j} \bigg/ \left\| \frac{\partial \mathbf{p}(h_j, h_k)}{\partial h_j} \right\| \quad \mathbf{t}_{pk}(h_j, h_k) = \frac{\partial \mathbf{p}(h_j, h_k)}{\partial h_k} \bigg/ \left\| \frac{\partial \mathbf{p}(h_j, h_k)}{\partial h_k} \right\| \quad (2)$$

with h_j and h_k as the introduced parameters.

3.3 Initial forces

Tangentially to initial load path curves act initial forces, which represent a projection of the state of stress of the membrane surface. Since initial forces are internal forces and have thus no defined direction, they are denoted by the scalars σ_{pj} and σ_{pk} for the respective directions describing only their magnitude. As customary tensile forces are

positive and compressive forces negative. The unit of initial forces is $[N/m]$. An initial force vector is obtained by scalar multiplication with a unit speed tangent vector.

If a projection surface is not planar deviation forces are necessary in order to equilibrate the initial forces acting tangentially to it. Deviation forces will be denoted by the vector \mathbf{d}_p and are assumed to be scalings of the chosen projection vector \mathbf{n}_p . Since initial forces are projections of the state of stress of the membrane surface the projection of external loads \mathbf{q}_p effects the initial state of stress.

For a point on the projection surface the following relation of forces is given:

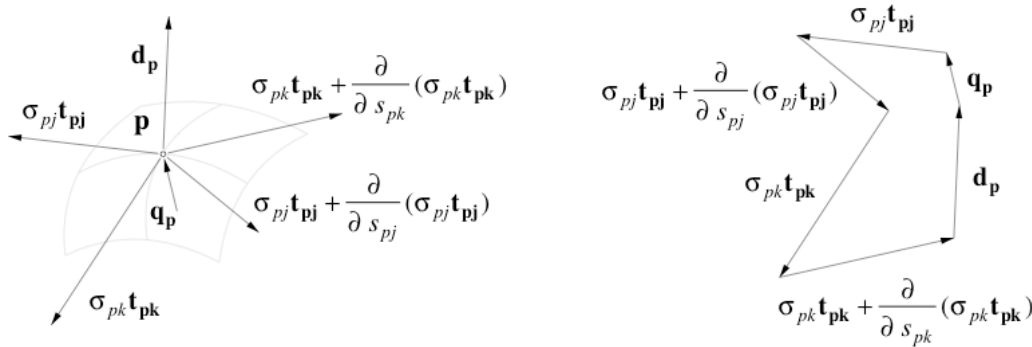

Fig. 2: form (left) and force diagram (right) for initial forces of a curved projection surface in axonometrical view

From figure 2 follows:

$$\mathbf{d}_p + \mathbf{q}_p + \sigma_{pj} \mathbf{t}_{pj} + \frac{\partial(\sigma_{pj} \mathbf{t}_{pj})}{\partial s_{pj}} + \sigma_{pj} (-\mathbf{t}_{pj}) + \sigma_{pk} \mathbf{t}_{pk} + \frac{\partial(\sigma_{pk} \mathbf{t}_{pk})}{\partial s_{pk}} + \sigma_{pk} (-\mathbf{t}_{pk}) = 0 \quad (3)$$

which can be simplified to:

$$\mathbf{d}_p + \mathbf{q}_p + \frac{\partial(\sigma_{pj} \mathbf{t}_{pj})}{\partial s_{pj}} + \frac{\partial(\sigma_{pk} \mathbf{t}_{pk})}{\partial s_{pk}} = 0 \quad (4)$$

By integration with respect to the respective arc length the equations for initial forces result in:

$$\sigma_{pj} \mathbf{t}_{pj} = \sigma_{pj0} \mathbf{t}_{pj0} - \int_0^u \mathbf{q}_p ds_{pj} - \int_0^u \mathbf{d}_p ds_{pj} - \int_0^u \frac{\partial(\sigma_{pk} \mathbf{t}_{pk})}{\partial s_{pk}} ds_{pj} \quad (5a)$$

$$\sigma_{pk} \mathbf{t}_{pk} = \sigma_{pk0} \mathbf{t}_{pk0} - \int_0^v \mathbf{q}_p ds_{pk} - \int_0^v \mathbf{d}_p ds_{pk} - \int_0^v \frac{\partial(\sigma_{pj} \mathbf{t}_{pj})}{\partial s_{pj}} ds_{pk} \quad (5b)$$

Due to integration two integration constants occur in the equations of initial forces. These can be interpreted as starting values for initial forces, which are assumed to represent the initial forces of curves, where crossing a borderline, such that:

$$\sigma_{pj0} \mathbf{t}_{pj0} = \sigma_{pj}(0, s_{pk}) \mathbf{t}_{pj}(0, s_{pk}) \quad \text{and} \quad \sigma_{pk0} \mathbf{t}_{pk0} = \sigma_{pk}(s_{pj}, 0) \mathbf{t}_{pk}(s_{pj}, 0) \quad (6)$$

The proceeding of the method bases on using stress resultants instead of stresses. This provides the advantage that only two directions have to be considered for load transfer. If using stresses not only axial stresses but also shear stresses would occur at least when determining the state of stress within the membrane surface. However, to show the relation of this method to common approaches the transformation from stress resultants to stresses is shown in figure 3.

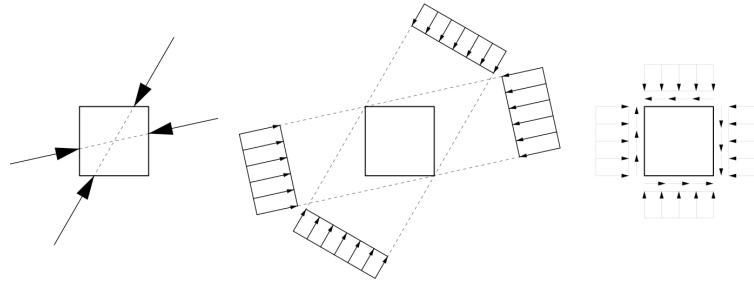

Fig. 3: Transformation of forces to stresses on an infinitesimal element

3.4 External loads

Mathematically external loads are represented by a continuous vector field. A load vector is denoted by \mathbf{q} . In order to avoid singularities the application of single loads is not possible. However, single loads never occur in reality, as they are always just a resultant of a distributed load. A load vector \mathbf{q} is divided into a tangential component \mathbf{q}_p , which is a linear combination of the tangent vectors \mathbf{t}_{pj} and \mathbf{t}_{pk} and is effecting the initial state of stress, and a component \mathbf{q}_n in direction of the projection vector, which is superposed with initial forces to determine the membrane surface.

3.5 Membrane surface

The membrane surface is the surface, which provides a reference surface for the membrane forces, which are acting tangentially to it. Its shape is thus determined by the run of these. The position vectors of the points of the membrane surface are determined by the vector function \mathbf{m} . The symbol \mathbf{m} will also be used as a representation of the membrane surface. The unit tangent vectors representing the direction of load transfer on the membrane surface are defined as follows:



$$\mathbf{t}_m = \frac{\partial \mathbf{m}}{\partial s_p} / \left\| \frac{\partial \mathbf{m}}{\partial s_p} \right\| \quad (7)$$

The derivative of a function of a curve with respect to its arc length gives a function defining unit speed tangent vectors. Vice versa the function of a curve will be obtained, if the unit speed tangent vector function and the arc length of the curve are given.

This method will be used to generate the membrane surface. As mentioned above, membrane forces will always be tangent to the respective membrane surface. The initial load paths on the projection surface represent projections of curves on the membrane surface. However, the arc lengths of these curves on the membrane surface can only be determined, if the function of the curves are known. Since these are unknown the arc lengths of the initial load path curves can be used, if the unit speed vector is multiplied with a scalar factor F_m . This correction factor will have to assure that the projection of the tangent vector of the membrane surface will coincide with the unit tangent vector on the projection surface \mathbf{t}_p . The relation of the unit tangent vector of the projection surface \mathbf{t}_p and the unit tangent vector of the membrane surface \mathbf{t}_m multiplied with its correction factor F_m is shown in figure 4.

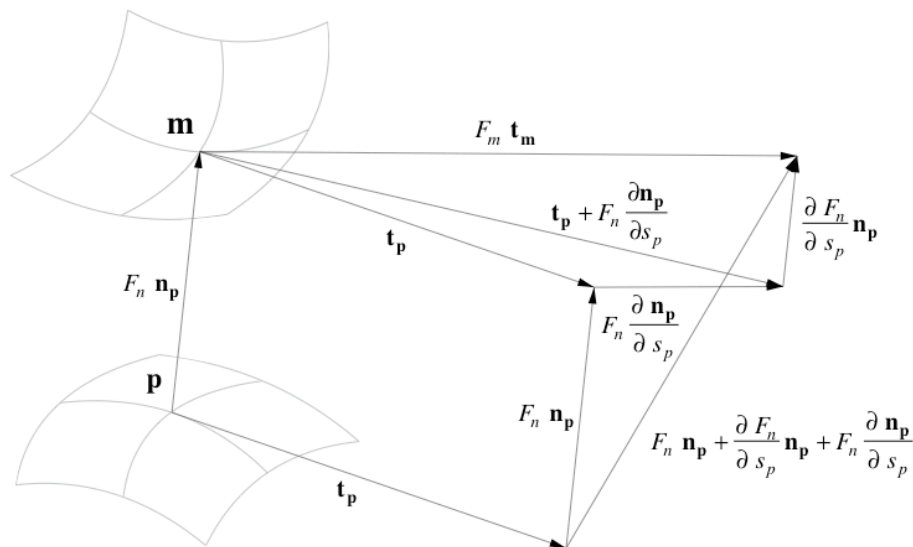

Fig. 4: Relation of the unit tangent vector to the projection surface and the unit tangent vector to the membrane surface multiplied with its correction factor

From figure 4 follows:



$$\begin{aligned}
 F_m \mathbf{t}_m &= \mathbf{t}_p + F_n \frac{\partial \mathbf{n}_p}{\partial s_p} + \frac{\partial F_n}{\partial s_p} \mathbf{n}_p & | \cdot \mathbf{t}_p \\
 F_m \mathbf{t}_m \cdot \mathbf{t}_p &= 1 + F_n \frac{\partial \mathbf{n}_p}{\partial s_p} \cdot \mathbf{t}_p + \frac{\partial F_n}{\partial s_p} \mathbf{n}_p \cdot \mathbf{t}_p & | \mathbf{t}_p \cdot \mathbf{t}_p = \|\mathbf{t}_p\|^2 = 1 \\
 F_m &= \frac{1}{\mathbf{t}_m \cdot \mathbf{t}_p} \left(1 + F_n \frac{\partial \mathbf{n}_p}{\partial s_p} \cdot \mathbf{t}_p + \frac{\partial F_n}{\partial s_p} \mathbf{n}_p \cdot \mathbf{t}_p \right)
 \end{aligned} \quad (8)$$

This applied to the equation of the derivative of \mathbf{m} gives:

$$\frac{\partial \mathbf{m}}{\partial s_p} = F_m \mathbf{t}_m \Rightarrow \frac{\partial \mathbf{m}}{\partial s_p} = \frac{\mathbf{t}_m}{\mathbf{t}_m \cdot \mathbf{t}_p} \left(1 + F_n \frac{\partial \mathbf{n}_p}{\partial s_p} \cdot \mathbf{t}_p + \frac{\partial F_n}{\partial s_p} \mathbf{n}_p \cdot \mathbf{t}_p \right) \quad (9)$$

3.6 Membrane forces

Membrane forces describe the actual state of stress along a membrane surface. They are internal forces and as mentioned in section 3.3 the magnitude of internal forces is described by scalars and a force vector is obtained by multiplication with a unit tangent vector.

For a point on the membrane surface the following relation of forces is given:

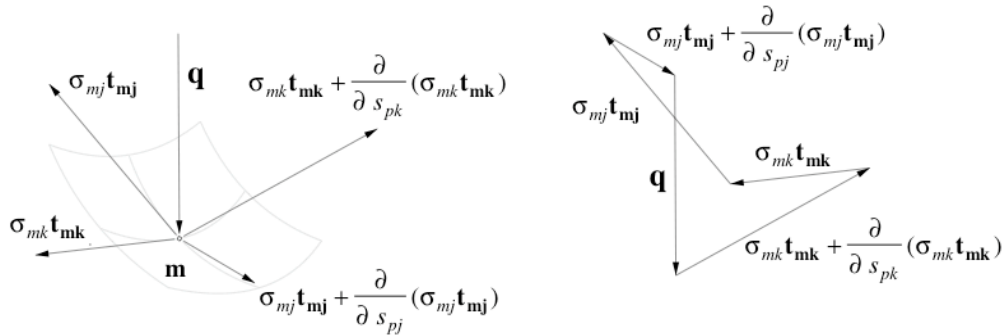

Fig. 5: form (left) and force diagram (right) for membrane forces in axonometrical view

From figure 5 follows:

$$\sigma_{mj} \mathbf{t}_{mj} + \frac{\partial(\sigma_{mj} \mathbf{t}_{mj})}{\partial s_{pj}} + \sigma_{mj} (-\mathbf{t}_{mj}) + \sigma_{mk} \mathbf{t}_{mk} + \frac{\partial(\sigma_{mk} \mathbf{t}_{mk})}{\partial s_{pk}} + \sigma_{mk} (-\mathbf{t}_{mk}) + \mathbf{q} = 0 \quad (10)$$

which can be simplified to:



$$\frac{\partial(\sigma_{mj} \mathbf{t}_{mj})}{\partial s_{pj}} + \frac{\partial(\sigma_{mk} \mathbf{t}_{mk})}{\partial s_{pk}} + \mathbf{q} = 0 \quad (11)$$

By integration with respect to the respective arc length the equations for membrane forces result in:

$$\sigma_{mj} \mathbf{t}_{pj} = \sigma_{pj0} \mathbf{t}_{pj0} - \int_0^u \mathbf{q} ds_{pj} - \int_0^u \frac{\partial(\sigma_{mk} \mathbf{t}_{mk})}{\partial s_{pk}} ds_{pj} \quad (12a)$$

$$\sigma_{mk} \mathbf{t}_{pk} = \sigma_{pk0} \mathbf{t}_{pk0} - \int_0^v \mathbf{q} ds_{pk} - \int_0^v \frac{\partial(\sigma_{mj} \mathbf{t}_{mj})}{\partial s_{pj}} ds_{pk} \quad (12b)$$

Due to integration two integration constants occur in the equations of membrane forces. As defined in section 3.2 initial and membrane forces coincide where crossing a borderline. Since the magnitude of initial forces crossing a borderline is defined to be the starting value (see 3.3), the interpretation of the integration constants is the same as for initial forces.

As equation (11) illustrates, membrane forces are dependent on the unit tangent vectors to the membrane surface. Thus it is not possible in general to determine the membrane forces without having the overall solution for the membrane surface.

3.7 Generation of membrane surfaces based on constant projection

As indicated in section 2 two types of projection are distinguished for the proposed method. This distinction is caused by fundamentally different relations of initial and membrane forces for either type of projection, as it will be discussed in section 4. Constant projection means that to every point on the projection surface the same projection vector \mathbf{n}_p is assigned, such that:

$$\frac{\partial \mathbf{n}_p}{\partial s_p} = 0 \quad (13)$$

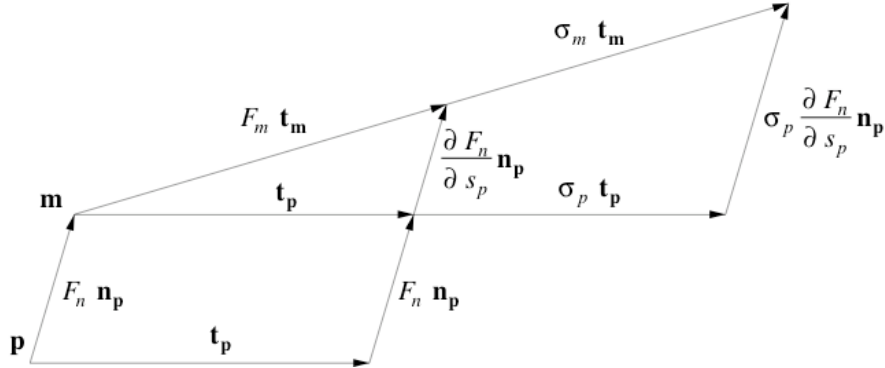

Fig. 6: relation of initial and membrane forces in case of constant projection

From the relation of initial and membrane forces illustrated in figure 6 follows:

$$\sigma_m \mathbf{t}_m = \sigma_p \left(\mathbf{t}_p + \frac{\partial F_n}{\partial s_p} \mathbf{n}_p \right) \quad (14)$$

Due to (13) equation (9) simplifies and results enlarged with σ_m in:

$$\frac{\partial \mathbf{m}}{\partial s_p} = \frac{\sigma_m \mathbf{t}_m}{\sigma_m \mathbf{t}_m \cdot \mathbf{t}_p} \left(1 + \frac{\partial F_n}{\partial s_p} \mathbf{n}_p \cdot \mathbf{t}_p \right) \quad (15)$$

By substitution with (14) equation 15 leads to the following relation:

$$\sigma_m \mathbf{t}_m = \frac{\partial \mathbf{m}}{\partial s_p} \sigma_p \quad (16)$$

Its derivative results in:

$$\frac{\partial(\sigma_m \mathbf{t}_m)}{\partial s_p} = \frac{\partial \mathbf{m}}{\partial s_p} \frac{\partial \sigma_p}{\partial s_p} + \frac{\partial^2 \mathbf{m}}{\partial s_p^2} \sigma_p \quad (17)$$

The differential equation describing any kind of membrane surface based on constant projection is obtained by applying (3.17) to (3.11):

$$\frac{\partial \mathbf{m}}{\partial s_{pj}} \frac{\partial \sigma_{pj}}{\partial s_{pj}} + \frac{\partial^2 \mathbf{m}}{\partial s_{pj}^2} \sigma_{pj} + \frac{\partial \mathbf{m}}{\partial s_{pk}} \frac{\partial \sigma_{pk}}{\partial s_{pk}} + \frac{\partial^2 \mathbf{m}}{\partial s_{pk}^2} \sigma_{pk} + \mathbf{q} = 0 \quad (18)$$



3.7.1 Example

The following simple example is meant to illustrate the application of the generation of membrane surfaces based on constant projection. Projection surface, initial load paths and the constant projection vector field are assumed as indicated in figure 7 and only vertical loads are applied to the projection surface. All points along the edges of the projection surface are fixed. From the made assumptions follows:

$$\mathbf{p} = \begin{pmatrix} s_{pj} \\ s_{pk} \\ 0 \end{pmatrix} \quad \mathbf{n}_p = \begin{pmatrix} 0 \\ 0 \\ 1 \end{pmatrix} \quad \mathbf{q} = \begin{pmatrix} 0 \\ 0 \\ q_z \end{pmatrix} \quad q_z = \text{const.}$$

Since the chosen load paths are straight and loads are perpendicular to the projection surface, from equations (5) follows that:

$$\sigma_{pj} = \sigma_{pj0} \quad \text{and} \quad \sigma_{pk} = \sigma_{pk0}$$

Due to the made assumptions equation (18) simplifies to:

$$\frac{\partial^2 \mathbf{m}}{\partial s_{pj}^2} \sigma_{pj0} + \frac{\partial^2 \mathbf{m}}{\partial s_{pk}^2} \sigma_{pk0} + \begin{pmatrix} 0 \\ 0 \\ q_z \end{pmatrix} = 0$$

As it is characteristic of partial differential equations there exist multiple solutions. Thus, an additional assumption has to be made in order to choose one of the solutions. In this example an equal load distribution into the both directions of load path curves is assumed. The function for the membrane surface \mathbf{m} results in:

$$\mathbf{m} = \begin{pmatrix} s_{pj} \\ s_{pk} \\ -q_z/4 \sigma_{pj0} s_{pj}^2 - q_z/4 \sigma_{pk0} s_{pk}^2 \end{pmatrix}$$

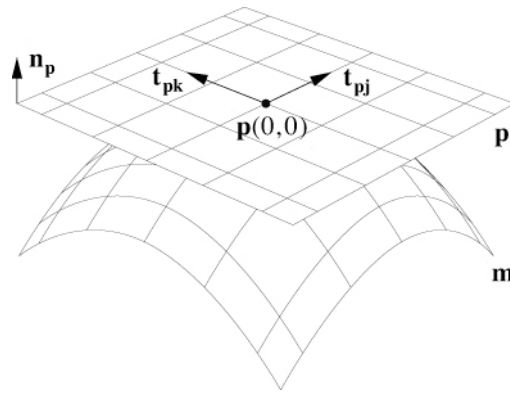

Fig. 7: planar projection surface with indicated straight load paths and the resulting membrane surface

3.8 Generation of membrane surfaces based on varying projection

The equation deduced in this section is generally applicable to develop a curved stress field describing the state of stress of any kind of surface structure. Every other case including section 3.7 can be deduced from this one. In contrast to constant projection no relation between initial forces and projection forces can be found for the general approach. Although the concept of varying projection vectors works for the projection of points, it does not for forces.

Multiplying both sides of equation (9) with σ_m gives the following equation for membrane forces:

$$\sigma_m \mathbf{t}_m = \frac{\partial \mathbf{m}}{\partial s_p} (\sigma_m \mathbf{t}_m \cdot \mathbf{t}_p) \left(1 + \frac{\partial F_n}{\partial s_p} \mathbf{n}_p \cdot \mathbf{t}_p \right)^{-1} \quad (19)$$

The respective derivative with respect to s_p results in:



$$\begin{aligned}
 \frac{\partial(\sigma_m \mathbf{t}_m)}{\partial s_p} &= \frac{\partial^2 \mathbf{m}}{\partial s_p^2} (\sigma_m \mathbf{t}_m \cdot \mathbf{t}_p) \left(1 + \frac{\partial F_n}{\partial s_p} \mathbf{n}_p \cdot \mathbf{t}_p \right)^{-1} \\
 &+ \frac{\partial \mathbf{m}}{\partial s_p} \left[\left(\frac{\partial \sigma_m}{\partial s_p} \mathbf{t}_m + \sigma_m \frac{\partial \mathbf{t}_m}{\partial s_p} \right) \cdot \mathbf{t}_p + \sigma_m \mathbf{t}_m \cdot \frac{\partial \mathbf{t}_p}{\partial s_p} \right] \left(1 + \frac{\partial F_n}{\partial s_p} \mathbf{n}_p \cdot \mathbf{t}_p \right)^{-1} \\
 &+ \frac{\partial \mathbf{m}}{\partial s_p} (\sigma_m \mathbf{t}_m \cdot \mathbf{t}_p) \left(\frac{\partial^2 (F_n \mathbf{n}_p)}{\partial s_p^2} \cdot \mathbf{t}_p + \frac{\partial (F_n \mathbf{n}_p)}{\partial s_p} \cdot \frac{\partial \mathbf{t}_p}{\partial s_p} \right) \left(1 + \frac{\partial F_n}{\partial s_p} \mathbf{n}_p \cdot \mathbf{t}_p \right)^{-2}
 \end{aligned} \quad (20)$$

The general differential equation is obtained by applying (20) to (11):

$$\begin{aligned}
 &\frac{\partial^2 \mathbf{m}}{\partial s_{pj}^2} (\sigma_{mj} \mathbf{t}_{mj} \cdot \mathbf{t}_{pj}) \left(1 + \frac{\partial F_n}{\partial s_{pj}} \mathbf{n}_p \cdot \mathbf{t}_{pj} \right)^{-1} + \frac{\partial \mathbf{m}}{\partial s_{pj}} \left[\left(\frac{\partial \sigma_{mj}}{\partial s_{pj}} \mathbf{t}_{mj} + \sigma_{mj} \frac{\partial \mathbf{t}_{mj}}{\partial s_{pj}} \right) \cdot \mathbf{t}_{pj} \right. \\
 &\quad \left. + \sigma_{mj} \mathbf{t}_{mj} \cdot \frac{\partial \mathbf{t}_{pj}}{\partial s_{pj}} \right] \\
 &\cdot \left(1 + \frac{\partial F_n}{\partial s_{pj}} \mathbf{n}_p \cdot \mathbf{t}_{pj} \right)^{-1} + \frac{\partial \mathbf{m}}{\partial s_{pj}} (\sigma_{mj} \mathbf{t}_{mj} \cdot \mathbf{t}_{pj}) \left(\frac{\partial^2 (F_n \mathbf{n}_p)}{\partial s_{pj}^2} \cdot \mathbf{t}_{pj} + \frac{\partial (F_n \mathbf{n}_p)}{\partial s_{pj}} \cdot \frac{\partial \mathbf{t}_{pj}}{\partial s_{pj}} \right) \\
 &\cdot \left(1 + \frac{\partial F_n}{\partial s_{pj}} \mathbf{n}_p \cdot \mathbf{t}_{pj} \right)^{-2} + \frac{\partial^2 \mathbf{m}}{\partial s_{pk}^2} (\sigma_{mk} \mathbf{t}_{mk} \cdot \mathbf{t}_{pk}) \left(1 + \frac{\partial F_n}{\partial s_{pk}} \mathbf{n}_p \cdot \mathbf{t}_{pk} \right)^{-1} \\
 &+ \frac{\partial \mathbf{m}}{\partial s_{pk}} \left[\left(\frac{\partial \sigma_{mk}}{\partial s_{pk}} \mathbf{t}_{mk} + \sigma_{mk} \frac{\partial \mathbf{t}_{mk}}{\partial s_{pk}} \right) \cdot \mathbf{t}_{pk} + \sigma_{mk} \mathbf{t}_{mk} \cdot \frac{\partial \mathbf{t}_{pk}}{\partial s_{pk}} \right] \cdot \left(1 + \frac{\partial F_n}{\partial s_{pk}} \mathbf{n}_p \cdot \mathbf{t}_{pk} \right)^{-1} \\
 &+ \frac{\partial \mathbf{m}}{\partial s_{pk}} (\sigma_{mk} \mathbf{t}_{mk} \cdot \mathbf{t}_{pk}) \left(\frac{\partial^2 (F_n \mathbf{n}_p)}{\partial s_{pk}^2} \cdot \mathbf{t}_{pk} + \frac{\partial (F_n \mathbf{n}_p)}{\partial s_{pk}} \cdot \frac{\partial \mathbf{t}_{pk}}{\partial s_{pk}} \right) \left(1 + \frac{\partial F_n}{\partial s_{pk}} \mathbf{n}_p \cdot \mathbf{t}_{pk} \right)^{-2} \\
 &+ \mathbf{q} = 0 \quad \text{with} \quad F_n = (\mathbf{m} - \mathbf{p}) \cdot \mathbf{n}_p \quad \text{and} \quad \mathbf{t}_m = \frac{\partial \mathbf{m}}{\partial s_p} / \left\| \frac{\partial \mathbf{m}}{\partial s_p} \right\|
 \end{aligned} \quad (21)$$

4 Discussion

The aim to develop a method to determine continuous curved stress fields was achieved. The found solution is based on differential geometry and the idea that forces along a surface are represented by tangential vector fields. It has been deduced from equilibrium conditions referring to points on membrane surfaces. In contrast to this approach common considerations are based on equilibrium conditions of infinitesimal small elements [4, 11] being a result from the description of internal forces with stresses. As shown in section 3.3 internal forces can also be described by stress resultants, while equilibrium is still guaranteed. The clear advantage of this concept of formulating an



equilibrium condition is that only two directions of forces instead of normal and shear stresses have to be considered. Furthermore the equilibrium conditions are free from geometrical descriptions, which have to be considered consequentially if using an element of a surface.

The proposed method is based on the concept of creating a surface, which represents a projection of the aspired membrane surface. This intermediate step is fundamental in order to have a means to control the transfer of loads. Since the shape of the membrane surface is still unknown load paths are designed on the projection surface instead, while still being able to control load transfer on the membrane surface. These load paths describe metaphorically speaking the flow of loads to the supports. Due to the defined relation of projection and membrane surface load paths define a projection of the actual load transfer.

A membrane surface is obtained by superposition of an initial state of stress defined on a projection surface and the actual loads. A quite obvious result from this basic assumption is to define projection as a movement of points along the lines of application of the applied loads. Although this might be a useful approach to a wide range of examples, it can cause problems especially considering curved projection surfaces, where the condition that a projection vector must not be tangential to a projection surface is violated in the case of partially tangential loads (see 3.1). This condition has been introduced to avoid the occurrence of tangential deviation forces, since these are defined as scalar multiplications of the projection vector (see 3.3). And this definition in turn was made in order to be able to deduce membrane forces from initial forces as illustrated in figure 6.

The proposed method is based on the common idea of the lower-bound theorem of the theory of plasticity. In contrast to that basic idea other approaches like the derivation of load distribution according to the Biot-Savart law used in electro-magnetic theory have been used [4]. Although the assumption that load distribution coincides with the propagation of a magnetic field might lead to good results, it should not limit the possibilities to transfer loads, since it is not theoretically justified with respect to static considerations. However, this approach can be considered to be one of the infinite possibilities to describe load transfer.

Two different types of projection have been distinguished in the proposed method, constant (3.7) and varying projection (3.8). For either type of projection there exists a counterpart for each point of the membrane surface on the projection surface. A difference between these two approaches occurs considering the relation of initial and membrane forces. In case of constant projection a direct relation between these two forces was found as illustrated in figure 6. This has been possible due to the fact that the integral of all load vectors in direction of projection \mathbf{q}_n with respect to an arc length is a scalar multiplication of the projection vector. Regarding varying projection this does not apply. Thus initial forces are no projections of membrane forces in this case. As a result the determination of initial forces is omitted for the generation of membrane surfaces by varying projection. However, the intermediate step of creating load paths on a projection surface is maintained, since by this means still a control over load transfer is achieved.



Major control over load transfer is achieved in case of constant projection by load paths and initial forces. However, specific boundary conditions may be necessary in order to choose one of the solutions of the partial differential equation, since in general differential equations have multiple solutions. As stated before, initial forces cannot be used in case of varying projection. However load transfer is at least geometrically controlled by load paths and in comparison with constant projection an additional approach for the magnitude of membrane forces specifically chosen for the particular problem under consideration has to be made.

Both equations determining membrane surfaces in either case of projection are partial differential equations of second order. Due to fundamental mathematical difficulties there is no possibility to find a general solution for these. Thus, the usability of the continuous approach of the proposed method is limited.

To achieve a generally applicable method a numerical approach is aspired. However, the proposed procedure as described in section 2 will be kept, instead of using a general mathematical numerical approach like finite difference method [4]. An advantage of a completely numerical approach is, that in contrast to a continuous approach discontinuities of forces and loads are possible.

References

- [1] Institut für Architektur und Raumplanung, Hochschule Liechtenstein, Ed. CAM of Freeforms in Architecture, vol. 3 of Positionen Architektur. Michael Imhof Verlag, 2008.
- [2] Laffranchi M. Ulrich Müther Schalenbauten. Verlag Niggli AG, 2008, ch. Betonschalenbauten – Eine geschichtliche Persepektive, pp. 16-29.
- [3] Block P. Thrust Network Analysis – Exploring Three-dimensional Equilibrium. PhD thesis, Massachusetts Institute of Technology, 2009.
- [4] Williams C. The generation of a class of structural forms for vaults and sails. *The Structural Engineer* 1990; **68**: 231-235.
- [5] Drucker DC. On structural concrete and the theorems of limit analysis. *International Association for Bridge and Structural Engineering Publications* 1961; **21**: 49-59.
- [6] Muttoni A, Schwartz J and Thürlimann B. Design of Concrete Structures with Stress Fields. Birkhäuser Verlag, Basel, 1997.
- [7] Prager W and Hodge PG. Theory of Perfectly Plastic Solids. John Wiley & Sons, Inc., New York, 1951.
- [8] Muttoni A. Die Anwendbarkeit der Plastizitätstheorie in der Bemessung von Stahlbeton. PhD thesis, ETH Zurich, 1989.
- [9] Muttoni A. L'art des structures. Presses polytechniques et universitaires romandes, Lausanne, 2004.
- [10] Cao H-D and Yau S-T, Eds. Geometric Flows, vol. XII of Surveys in Differential Geometry. International Press, 2008.



- [11] Timoshenko SP. Theory of plates and shells, first ed. McGraw-Hill, New York, 1940.